



Installer reference guide

Daikin room air conditioner



FTXF20C5V1B
FTXF25C5V1B
FTXF35C5V1B
FTXF42C5V1B
ATXF20C5V1B
ATXF25C5V1B
ATXF35C5V1B
ATXF42C5V1B

Table of contents

1	About the documentation	4
1.1	About this document	4
1.2	Installer reference guide at a glance	5
2	General safety precautions	6
2.1	About the documentation	6
2.1.1	Meaning of warnings and symbols	6
2.2	For the installer	7
2.2.1	General	7
2.2.2	Installation site	8
2.2.3	Refrigerant — in case of R410A or R32.....	11
2.2.4	Electrical	13
3	Specific installer safety instructions	16
4	About the box	21
4.1	Overview: About the box	21
4.2	Indoor unit	21
4.2.1	To unpack the indoor unit	21
4.2.2	To remove the accessories from the indoor unit	22
5	About the unit	23
5.1	System layout	23
5.2	Operation range	23
6	Unit installation	24
6.1	Preparing the installation site	24
6.1.1	Installation site requirements of the indoor unit	24
6.2	Opening the indoor unit	25
6.2.1	To remove the front panel	25
6.2.2	To re-install the front panel	26
6.2.3	To remove the front grille	26
6.2.4	To re-install the front grille	27
6.2.5	To remove the electrical wiring box cover	27
6.2.6	To open the service cover	27
6.3	Installing the indoor unit	28
6.3.1	Precautions when installing the indoor unit	28
6.3.2	To install the mounting plate	28
6.3.3	To drill a wall hole	28
6.3.4	To remove the pipe port cover	29
6.3.5	To provide drainage	29
7	Piping installation	33
7.1	Preparing refrigerant piping	33
7.1.1	Refrigerant piping requirements	33
7.1.2	Refrigerant piping insulation	34
7.2	Connecting the refrigerant piping	34
7.2.1	About connecting the refrigerant piping	34
7.2.2	Precautions when connecting the refrigerant piping	34
7.2.3	Guidelines when connecting the refrigerant piping	35
7.2.4	Pipe bending guidelines	36
7.2.5	To flare the pipe end	36
7.2.6	To connect the refrigerant piping to the indoor unit	37
8	Electrical installation	38
8.1	Connecting the electrical wiring	38
8.1.1	About connecting the electrical wiring	38
8.1.2	Precautions when connecting the electrical wiring	38
8.1.3	Guidelines when connecting the electrical wiring	39
8.1.4	Specifications of standard wiring components	40
8.1.5	To connect the electrical wiring to the indoor unit	40
9	Finishing the indoor unit installation	42
9.1	To insulate the drain piping, refrigerant piping and interconnection cable	42
9.2	To pass the pipes through the wall hole	42
9.3	To fix the unit on the mounting plate	43

10 Configuration	44
10.1 To set a different address.....	44
11 Commissioning	46
11.1 Overview: Commissioning	46
11.2 Checklist before commissioning.....	46
11.3 To perform a test run.....	47
11.3.1 To perform a test run in winter season	47
12 Hand-over to the user	48
13 Disposal	49
14 Technical data	50
14.1 Wiring diagram.....	50
14.1.1 Unified wiring diagram legend.....	50
15 Glossary	53

1 About the documentation

1.1 About this document



INFORMATION

Make sure that the user has the printed documentation and ask him/her to keep it for future reference.

Target audience

Authorised installers



INFORMATION

This appliance is intended to be used by expert or trained users in shops, in light industry, and on farms, or for commercial and household use by lay persons.



WARNING

Make sure installation, servicing, maintenance, repair and applied materials follow the instructions from Daikin and, in addition, comply with applicable legislation and are performed by qualified persons only. In Europe and areas where IEC standards apply, EN/IEC 60335-2-40 is the applicable standard.

Documentation set

This document is part of a documentation set. The complete set consists of:

- **General safety precautions:**
 - Safety instructions that you **MUST** read before installing
 - Format: Paper (in the box of the indoor unit)
- **Indoor unit installation manual:**
 - Installation instructions
 - Format: Paper (in the box of the indoor unit)
- **Installer reference guide:**
 - Preparation of the installation, good practices, reference data,...
 - Format: Digital files on <http://www.daikineurope.com/support-and-manuals/product-information/>

Latest revisions of the supplied documentation may be available on the regional Daikin website or via your dealer.

The original documentation is written in English. All other languages are translations.

Technical engineering data

- A **subset** of the latest technical data is available on the regional Daikin website (publicly accessible).
- The **full set** of latest technical data is available on the Daikin Business Portal (authentication required).

1.2 Installer reference guide at a glance









Chapter	Description
General safety precautions	Safety instructions that you MUST read before installing
About the documentation	What documentation exists for the installer
About the box	How to unpack the units and remove their accessories
About the unit	<ul style="list-style-type: none"> ▪ System layout ▪ Operation range
Preparation	What to do and know before going on-site
Installation	What to do and know to install the system
Configuration	What to do and know to configure the system after it is installed
Commissioning	What to do and know to commission the system after it is configured
Hand-over to the user	What to give and explain to the user
Disposal	How to dispose of the system
Technical data	Specifications of the system
Glossary	Definition of terms

2 General safety precautions





2.1 About the documentation

- The original documentation is written in English. All other languages are translations.
- The precautions described in this document cover very important topics, follow them carefully.
- The installation of the system, and all activities described in the installation manual and in the installer reference guide **MUST** be performed by an authorised installer.



2.1.1 Meaning of warnings and symbols

	DANGER Indicates a situation that results in death or serious injury.
	DANGER: RISK OF ELECTROCUTION Indicates a situation that could result in electrocution.
	DANGER: RISK OF BURNING/SCALDING Indicates a situation that could result in burning/scalding because of extreme hot or cold temperatures.
	DANGER: RISK OF EXPLOSION Indicates a situation that could result in explosion.
	WARNING Indicates a situation that could result in death or serious injury.
	WARNING: FLAMMABLE MATERIAL
	CAUTION Indicates a situation that could result in minor or moderate injury.
	NOTICE Indicates a situation that could result in equipment or property damage.
	INFORMATION Indicates useful tips or additional information.

Symbols used on the unit:

Symbol	Explanation
	Before installation, read the installation and operation manual, and the wiring instruction sheet.
	Before performing maintenance and service tasks, read the service manual.
	For more information, see the installer and user reference guide.
	The unit contains rotating parts. Be careful when servicing or inspecting the unit.

Symbols used in the documentation:

Symbol	Explanation
	Indicates a figure title or a reference to it. Example: "▲ 1-3 Figure title" means "Figure 3 in chapter 1".
	Indicates a table title or a reference to it. Example: "■ 1-3 Table title" means "Table 3 in chapter 1".

2.2 For the installer

2.2.1 General

If you are NOT sure how to install or operate the unit, contact your dealer.



DANGER: RISK OF BURNING/SCALDING

- Do NOT touch the refrigerant piping, water piping or internal parts during and immediately after operation. It could be too hot or too cold. Give it time to return to normal temperature. If you MUST touch it, wear protective gloves.
- Do NOT touch any accidental leaking refrigerant.



WARNING

Improper installation or attachment of equipment or accessories could result in electrical shock, short-circuit, leaks, fire or other damage to the equipment. ONLY use accessories, optional equipment and spare parts made or approved by Daikin.



WARNING

Make sure installation, testing and applied materials comply with applicable legislation (on top of the instructions described in the Daikin documentation).



CAUTION

Wear adequate personal protective equipment (protective gloves, safety glasses,...) when installing, maintaining or servicing the system.



WARNING

Tear apart and throw away plastic packaging bags so that nobody, especially children, can play with them. Possible risk: suffocation.



WARNING

Provide adequate measures to prevent that the unit can be used as a shelter by small animals. Small animals that make contact with electrical parts can cause malfunctions, smoke or fire.



CAUTION

Do NOT touch the air inlet or aluminium fins of the unit.



CAUTION

- Do NOT place any objects or equipment on top of the unit.
- Do NOT sit, climb or stand on the unit.

In accordance with the applicable legislation, it might be necessary to provide a logbook with the product containing at least: information on maintenance, repair work, results of tests, stand-by periods,...

Also, at least, following information MUST be provided at an accessible place at the product:

- Instructions for shutting down the system in case of an emergency
- Name and address of fire department, police and hospital
- Name, address and day and night telephone numbers for obtaining service

In Europe, EN378 provides the necessary guidance for this logbook.

2.2.2 Installation site

- Provide sufficient space around the unit for servicing and air circulation.
- Make sure the installation site withstands the weight and vibration of the unit.
- Make sure the area is well ventilated. Do NOT block any ventilation openings.
- Make sure the unit is level.

Do NOT install the unit in the following places:

- In potentially explosive atmospheres.
- In places where there is machinery that emits electromagnetic waves. Electromagnetic waves may disturb the control system, and cause malfunction of the equipment.
- In places where there is a risk of fire due to the leakage of flammable gases (example: thinner or gasoline), carbon fibre, ignitable dust.
- In places where corrosive gas (example: sulphurous acid gas) is produced. Corrosion of copper pipes or soldered parts may cause the refrigerant to leak.
- In bathrooms.

Instructions for equipment using R32 refrigerant



WARNING: MILDLY FLAMMABLE MATERIAL

The refrigerant inside this unit is mildly flammable.

**WARNING**

- Do NOT pierce or burn.
- Do NOT use means to accelerate the defrosting process or to clean the equipment, other than those recommended by the manufacturer.
- Be aware that R32 refrigerant does NOT contain an odour.

**WARNING**

The appliance shall be stored so as to prevent mechanical damage and in a well-ventilated room without continuously operating ignition sources (example: open flames, an operating gas appliance or an operating electric heater) and have a room size as specified below.

**WARNING**

Make sure installation, servicing, maintenance and repair comply with instructions from Daikin and with applicable legislation and are executed ONLY by authorised persons.

**WARNING**

If one or more rooms are connected to the unit using a duct system, make sure:

- there are no operating ignition sources (example: open flames, an operating gas appliance or an operating electric heater) in case the floor area is less than the minimum floor area A (m²).
- no auxiliary devices, which may be a potential ignition source, are installed in the duct work (example: hot surfaces with a temperature exceeding 700°C and electric switching device);
- only auxiliary devices approved by the manufacturer are used in the duct work;
- air inlet AND outlet are connected directly to the same room by ducting. Do NOT use spaces such as a false ceiling as a duct for the air inlet or outlet.

**NOTICE**

- Precautions shall be taken to avoid excessive vibration or pulsation to refrigeration piping.
- Protection devices, piping and fittings shall be protected as far as possible against adverse environmental effects.
- Provision shall be made for expansion and contraction of long runs of piping.
- Piping in refrigerating systems shall be designed and installed such as to minimise the likelihood of hydraulic shock damaging the system.
- The indoor equipment and pipes shall be securely mounted and guarded such that accidental rupture of equipment or pipes cannot occur from events such as moving furniture or reconstruction activities.

**CAUTION**

Do NOT use potential sources of ignition in searching for or detection of refrigerant leaks.

**NOTICE**

- Do NOT re-use joints and copper gaskets which have been used already.
- Joints made in installation between parts of refrigerant system shall be accessible for maintenance purposes.

Installation space requirements

WARNING

If appliances contain R32 refrigerant, the floor area of the room in which the appliances are installed, operated and stored **MUST** be larger than the minimum floor area defined in table below A (m²). This applies to:

- Indoor units **without** a refrigerant leakage sensor; in case of indoor units **with** refrigerant leakage sensor, consult the installation manual
- Outdoor units installed or stored indoors (e.g. winter garden, garage, machinery room)

NOTICE

- Pipework shall be protected from physical damage.
- Installation of pipework shall be kept to a minimum.

To determine the minimum floor area

- Determine the total refrigerant charge in the system (= factory refrigerant charge ① + ② additional refrigerant amount charged).

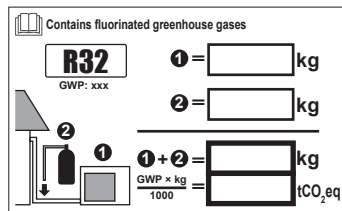

- Determine which graph or table to use.
 - For indoor units: Is the unit ceiling-mounted, wall-mounted or floor-standing?
 - For outdoor units installed or stored indoors, this depends on the installation height:

If the installation height is...	Then use the graph or table for...
<1.8 m	Floor-standing units
1.8 ≤ x < 2.2 m	Wall-mounted units
≥ 2.2 m	Ceiling-mounted units

- Use the graph or table to determine the minimum floor area.

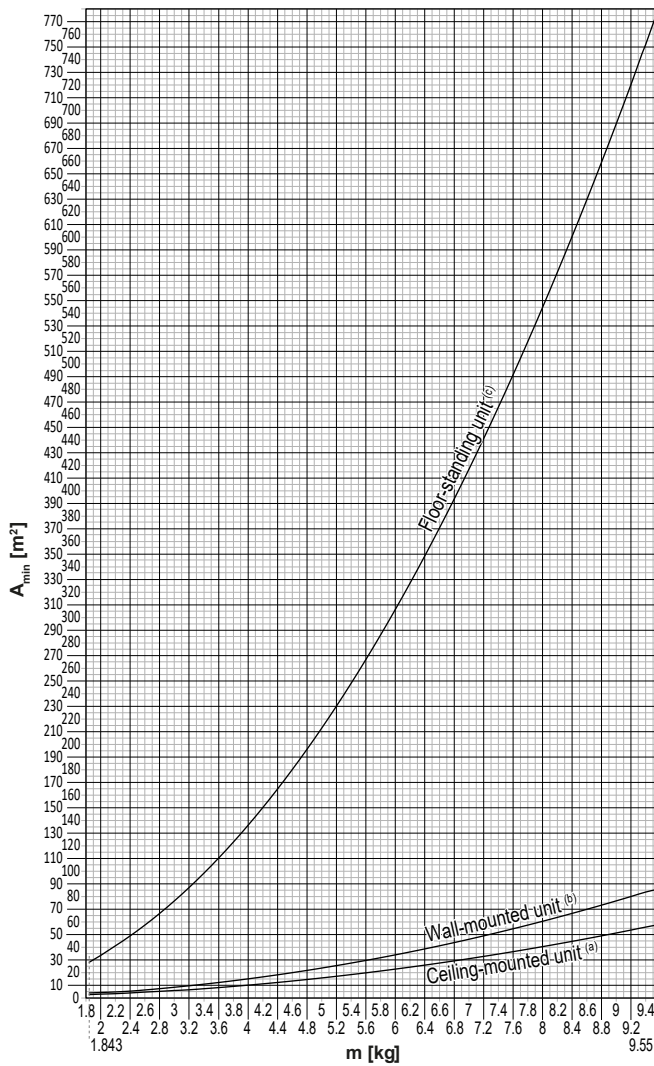

Ceiling-mounted unit ^(a)		Wall-mounted unit ^(b)		Floor-standing unit ^(c)	
m (kg)	A _{min} (m ²)	m (kg)	A _{min} (m ²)	m (kg)	A _{min} (m ²)
≤1.842	—	≤1.842	—	≤1.842	—
1.843	3.64	1.843	4.45	1.843	28.9
2.0	3.95	2.0	4.83	2.0	34.0
2.2	4.34	2.2	5.31	2.2	41.2
2.4	4.74	2.4	5.79	2.4	49.0
2.6	5.13	2.6	6.39	2.6	57.5
2.8	5.53	2.8	7.41	2.8	66.7
3.0	5.92	3.0	8.51	3.0	76.6
3.2	6.48	3.2	9.68	3.2	87.2
3.4	7.32	3.4	10.9	3.4	98.4
3.6	8.20	3.6	12.3	3.6	110
3.8	9.14	3.8	13.7	3.8	123
4.0	10.1	4.0	15.1	4.0	136
4.2	11.2	4.2	16.7	4.2	150
4.4	12.3	4.4	18.3	4.4	165
4.6	13.4	4.6	20.0	4.6	180
4.8	14.6	4.8	21.8	4.8	196
5.0	15.8	5.0	23.6	5.0	213
5.2	17.1	5.2	25.6	5.2	230
5.4	18.5	5.4	27.6	5.4	248
5.6	19.9	5.6	29.7	5.6	267
5.8	21.3	5.8	31.8	5.8	286
6.0	22.8	6.0	34.0	6.0	306
6.2	24.3	6.2	36.4	6.2	327
6.4	25.9	6.4	38.7	6.4	349
6.6	27.6	6.6	41.2	6.6	371
6.8	29.3	6.8	43.7	6.8	394
7.0	31.0	7.0	46.3	7.0	417
7.2	32.8	7.2	49.0	7.2	441
7.4	34.7	7.4	51.8	7.4	466
7.6	36.6	7.6	54.6	7.6	492
7.8	38.5	7.8	57.5	7.8	518
8	40.5	8	60.5	8	545
8.2	42.6	8.2	63.6	8.2	572
8.4	44.7	8.4	66.7	8.4	601
8.6	46.8	8.6	69.9	8.6	629
8.8	49.0	8.8	73.2	8.8	659
9	51.3	9	76.6	9	689
9.2	53.6	9.2	80.0	9.2	720
9.4	55.9	9.4	83.6	9.4	752
9.55	57.7	9.55	86.2	9.55	776

- m** Total refrigerant charge in the system
- A_{min}** Minimum floor area
- (a)** Ceiling-mounted unit (= Ceiling-mounted unit)
- (b)** Wall-mounted unit (= Wall-mounted unit)
- (c)** Floor-standing unit (= Floor-standing unit)

2.2.3 Refrigerant — in case of R410A or R32

If applicable. See the installation manual or installer reference guide of your application for more information.



NOTICE

Make sure refrigerant piping installation complies with applicable legislation. In Europe, EN378 is the applicable standard.



NOTICE

Make sure the field piping and connections are NOT subjected to stress.



WARNING

During tests, NEVER pressurise the product with a pressure higher than the maximum allowable pressure (as indicated on the nameplate of the unit).



WARNING

Take sufficient precautions in case of refrigerant leakage. If refrigerant gas leaks, ventilate the area immediately. Possible risks:

- Excessive refrigerant concentrations in a closed room can lead to oxygen deficiency.
- Toxic gas might be produced if refrigerant gas comes into contact with fire.



DANGER: RISK OF EXPLOSION

Pump down – Refrigerant leakage. If you want to pump down the system, and there is a leak in the refrigerant circuit:

- Do NOT use the unit's automatic pump down function, with which you can collect all refrigerant from the system into the outdoor unit. **Possible consequence:** Self-combustion and explosion of the compressor because of air going into the operating compressor.
- Use a separate recovery system so that the unit's compressor does NOT have to operate.



WARNING

ALWAYS recover the refrigerant. Do NOT release them directly into the environment. Use a vacuum pump to evacuate the installation.



NOTICE

After all the piping has been connected, make sure there is no gas leak. Use nitrogen to perform a gas leak detection.



NOTICE

- To avoid compressor breakdown, do NOT charge more than the specified amount of refrigerant.
- When the refrigerant system is to be opened, refrigerant MUST be treated according to the applicable legislation.





WARNING

Make sure there is no oxygen in the system. Refrigerant may ONLY be charged after performing the leak test and the vacuum drying.

Possible consequence: Self-combustion and explosion of the compressor because of oxygen going into the operating compressor.

- In case recharge is required, see the nameplate of the unit. It states the type of refrigerant and necessary amount.
- The unit is factory charged with refrigerant and depending on pipe sizes and pipe lengths some systems require additional charging of refrigerant.
- ONLY use tools exclusively for the refrigerant type used in the system, this to ensure pressure resistance and prevent foreign materials from entering into the system.
- Charge the liquid refrigerant as follows:

If	Then
A siphon tube is present (i.e., the cylinder is marked with "Liquid filling siphon attached")	Charge with the cylinder upright. 
A siphon tube is NOT present	Charge with the cylinder upside down. 

- Open refrigerant cylinders slowly.
- Charge the refrigerant in liquid form. Adding it in gas form may prevent normal operation.

**CAUTION**

When the refrigerant charging procedure is done or when pausing, close the valve of the refrigerant tank immediately. If the valve is NOT closed immediately, remaining pressure might charge additional refrigerant. **Possible consequence:** Incorrect refrigerant amount.

2.2.4 Electrical

**DANGER: RISK OF ELECTROCUTION**

- Turn OFF all power supply before removing the switch box cover, connecting electrical wiring or touching electrical parts.
- Disconnect the power supply for more than 10 minutes, and measure the voltage at the terminals of main circuit capacitors or electrical components before servicing. The voltage MUST be less than 50 V DC before you can touch electrical components. For the location of the terminals, see the wiring diagram.
- Do NOT touch electrical components with wet hands.
- Do NOT leave the unit unattended when the service cover is removed.

**WARNING**

If NOT factory installed, a main switch or other means for disconnection, having a contact separation in all poles providing full disconnection under overvoltage category III condition, MUST be installed in the fixed wiring.



WARNING

- ONLY use copper wires.
- Make sure the field wiring complies with the applicable legislation.
- All field wiring MUST be performed in accordance with the wiring diagram supplied with the product.
- NEVER squeeze bundled cables and make sure they do NOT come in contact with the piping and sharp edges. Make sure no external pressure is applied to the terminal connections.
- Make sure to install earth wiring. Do NOT earth the unit to a utility pipe, surge absorber, or telephone earth. Incomplete earth may cause electrical shock.
- Make sure to use a dedicated power circuit. NEVER use a power supply shared by another appliance.
- Make sure to install the required fuses or circuit breakers.
- Make sure to install an earth leakage protector. Failure to do so may cause electrical shock or fire.
- When installing the earth leakage protector, make sure it is compatible with the inverter (resistant to high frequency electric noise) to avoid unnecessary opening of the earth leakage protector.



CAUTION

- When connecting the power supply: connect the earth cable first, before making the current-carrying connections.
- When disconnecting the power supply: disconnect the current-carrying cables first, before separating the earth connection.
- The length of the conductors between the power supply stress relief and the terminal block itself MUST be as such that the current-carrying wires are tautened before the earth wire is in case the power supply is pulled loose from the stress relief.



NOTICE

Precautions when laying power wiring:



- Do NOT connect wiring of different thicknesses to the power terminal block (slack in the power wiring may cause abnormal heat).
- When connecting wiring which is the same thickness, do as shown in the figure above.
- For wiring, use the designated power wire and connect firmly, then secure to prevent outside pressure being exerted on the terminal board.
- Use an appropriate screwdriver for tightening the terminal screws. A screwdriver with a small head will damage the head and make proper tightening impossible.
- Over-tightening the terminal screws may break them.



WARNING

- After finishing the electrical work, confirm that each electrical component and terminal inside the electrical components box is connected securely.
- Make sure all covers are closed before starting up the unit.



NOTICE

ONLY applicable if the power supply is three-phase, and the compressor has an ON/OFF starting method.

If there exists the possibility of reversed phase after a momentary black out and the power goes ON and OFF while the product is operating, attach a reversed phase protection circuit locally. Running the product in reversed phase can break the compressor and other parts.

3 Specific installer safety instructions

Always observe the following safety instructions and regulations.

Unit installation (see "6 Unit installation" [▶ 24])



WARNING

Installation shall be done by an installer, the choice of materials and installation shall comply with the applicable legislation. In Europe, EN378 is the applicable standard.

Installation site (see "6.1 Preparing the installation site" [▶ 24])



CAUTION

- Check if the installation location can support the unit's weight. Poor installation is hazardous. It can also cause vibrations or unusual operating noise.
- Provide sufficient service space.
- Do NOT install the unit so that it is in contact with a ceiling or a wall, as this may cause vibrations.



WARNING

The appliance shall be stored in a room without continuously operating ignition sources (example: open flames, an operating gas appliance or an operating electric heater).

Connecting the refrigerant piping (see "7.2 Connecting the refrigerant piping" [▶ 34])



CAUTION

- No brazing or welding on site for units with R32 refrigerant charge during shipment.
- During installation of the refrigeration system, joining of parts with at least one part charged shall be performed taking into account the following requirements: inside occupied spaces non-permanent joints are NOT allowed for R32 refrigerant except for site made joints directly connecting the indoor unit to piping. Site made joints directly connecting piping to indoor units shall be of non-permanent type.



CAUTION

- Use the flare nut fixed to the unit.
- To prevent gas leakage, apply refrigeration oil ONLY to the inside of the flare. Use refrigeration oil for R32.
- Do NOT reuse joints.



CAUTION

- Do NOT use mineral oil on flared part.
- Do NOT reuse piping from previous installations.
- NEVER install a drier to this R32 unit to guarantee its lifetime. The drying material may dissolve and damage the system.

**WARNING**

Connect the refrigerant piping securely before running the compressor. If the refrigerant piping is NOT connected and the stop valve is open when the compressor is run, air will be sucked in. This will cause abnormal pressure in the refrigeration cycle, which may result in equipment damage and even injury.

**CAUTION**

- Incomplete flaring may cause refrigerant gas leakage.
- Do NOT re-use flares. Use new flares to prevent refrigerant gas leakage.
- Use flare nuts that are included with the unit. Using different flare nuts may cause refrigerant gas leakage.

**CAUTION**

Do NOT open the valves before flaring is complete. This would cause refrigerant gas leakage.

**DANGER: RISK OF EXPLOSION**

Do NOT start the unit if it is vacuumed.

Charging refrigerant (see Charging refrigerant)**WARNING**

The refrigerant inside the unit is mildly flammable, but normally does NOT leak. If the refrigerant leaks in the room and comes in contact with fire from a burner, a heater, or a cooker, this may result in fire, or the formation of a harmful gas.

Turn off any combustible heating devices, ventilate the room, and contact the dealer where you purchased the unit.

Do NOT use the unit until a service person confirms that the part from which the refrigerant leaked has been repaired.

**WARNING**

- Only use R32 as refrigerant. Other substances may cause explosions and accidents.
- R32 contains fluorinated greenhouse gases. Its global warming potential (GWP) value is 675. Do NOT vent these gases into the atmosphere.
- When charging refrigerant, ALWAYS use protective gloves and safety glasses.

**CAUTION**

To avoid compressor breakdown, do NOT charge more than the specified amount of refrigerant.

**WARNING**

NEVER directly touch any accidental leaking refrigerant. This could result in severe wounds caused by frostbite.

Electrical installation (see "8 Electrical installation" [▶ 38])**WARNING**

Appliance MUST be installed in accordance with national wiring regulations.



WARNING

- All wiring **MUST** be performed by an authorised electrician and **MUST** comply with the applicable legislation.
- Make electrical connections to the fixed wiring.
- All components procured on-site and all electrical construction **MUST** comply with the applicable legislation.



WARNING

- If the power supply has a missing or wrong N-phase, equipment might break down.
- Establish proper earthing. Do **NOT** earth the unit to a utility pipe, surge absorber, or telephone earth. Incomplete earthing may cause electrical shock.
- Install the required fuses or circuit breakers.
- Secure the electrical wiring with cable ties so that the cables do **NOT** come in contact with sharp edges or piping, particularly on the high-pressure side.
- Do **NOT** use taped wires, stranded conductor wires, extension cords, or connections from a star system. They can cause overheating, electrical shock or fire.
- Do **NOT** install a phase advancing capacitor, because this unit is equipped with an inverter. A phase advancing capacitor will reduce performance and may cause accidents.



WARNING

ALWAYS use multicore cable for power supply cables.



WARNING

Use an all-pole disconnection type breaker with at least 3 mm between the contact point gaps that provide full disconnection under overvoltage category III.



WARNING

If the supply cord is damaged, it **MUST** be replaced by the manufacturer, its service agent or similarly qualified persons in order to avoid a hazard.



WARNING

Do **NOT** connect the power supply to the indoor unit. This could result in electrical shock or fire.



WARNING

- Do **NOT** use locally purchased electrical parts inside the product.
- Do **NOT** branch the power supply for the drain pump, etc. from the terminal block. This could result in electrical shock or fire.



WARNING

Keep the interconnection wiring away from copper pipes without thermal insulation as such pipes will be very hot.



DANGER: RISK OF ELECTROCUTION

All electrical parts (including thermistors) are powered by the power supply. Do **NOT** touch them with bare hands.

**DANGER: RISK OF ELECTROCUTION**

Disconnect the power supply for more than 10 minutes, and measure the voltage at the terminals of main circuit capacitors or electrical components before servicing. The voltage **MUST** be less than 50 V DC before you can touch electrical components. For the location of the terminals, see the wiring diagram.

Finishing indoor unit installation (see [Finishing the outdoor unit installation](#))**DANGER: RISK OF ELECTROCUTION**

- Make sure that the system is earthed properly.
- Turn OFF the power supply before servicing.
- Install the switch box cover before turning ON the power supply.

Commissioning (see ["11 Commissioning"](#) [▶ 46])**DANGER: RISK OF ELECTROCUTION****DANGER: RISK OF BURNING/SCALDING****CAUTION**

Do NOT perform the test operation while working on the indoor units.

When performing the test operation, NOT ONLY the outdoor unit, but the connected indoor unit will operate as well. Working on an indoor unit while performing a test operation is dangerous.

**CAUTION**

Do NOT insert fingers, rods or other objects into the air inlet or outlet. Do NOT remove the fan guard. When the fan is rotating at high speed, it will cause injury.

Maintenance and service (see [Maintenance and service](#))**DANGER: RISK OF ELECTROCUTION****DANGER: RISK OF BURNING/SCALDING****WARNING**

- Before carrying out any maintenance or repair activity, ALWAYS switch off the circuit breaker on the supply panel, remove the fuses or open the protection devices of the unit.
- Do NOT touch live parts for 10 minutes after the power supply is turned off because of high voltage risk.
- Please note that some sections of the electric component box are hot.
- Make sure you do NOT touch a conductive section.
- Do NOT rinse the unit. This may cause electric shocks or fire.



DANGER: RISK OF ELECTROCUTION

- Use this compressor on a grounded system only.
- Turn the power off before servicing the compressor.
- Reattach the switch box cover and service lid after servicing.



CAUTION

Always wear safety goggles and protective gloves.



DANGER: RISK OF EXPLOSION

- Use a pipe cutter to remove the compressor.
- Do NOT use the brazing torch.
- Use approved refrigerants and lubricants only.



DANGER: RISK OF BURNING/SCALDING

Do NOT touch the compressor with bare hands.

Troubleshooting (see Troubleshooting)



DANGER: RISK OF ELECTROCUTION



DANGER: RISK OF BURNING/SCALDING



WARNING

- When carrying out an inspection on the switch box of the unit, ALWAYS make sure that the unit is disconnected from the mains. Turn off the respective circuit breaker.
- When a safety device was activated, stop the unit and find out why the safety device was activated before resetting it. NEVER shunt safety devices or change their values to a value other than the factory default setting. If you are unable to find the cause of the problem, call your dealer.



WARNING

Prevent hazards due to inadvertent resetting of the thermal cut-out: power to this appliance MUST NOT be supplied through an external switching device, such as a timer, or connected to a circuit that is regularly turned ON and OFF by the utility.

4 About the box



4.1 Overview: About the box

This chapter describes what you have to do after the box with the indoor unit is delivered on-site.

It contains information about:

- Unpacking and handling the unit
- Removing the accessories from the unit

Keep the following in mind:

- At delivery, the unit **MUST** be checked for damage. Any damage **MUST** be reported immediately to the claims agent of the carrier.
- Bring the packed unit as close as possible to its final installation position to prevent damage during transport.
- When handling the unit, take into account the following:
 -  Fragile, handle the unit with care.
 -  Keep the unit upright in order to avoid damage.
- Prepare the path along which you want to bring the unit inside in advance.

4.2 Indoor unit



INFORMATION

The following figures are just examples and may NOT completely match your system layout.

4.2.1 To unpack the indoor unit

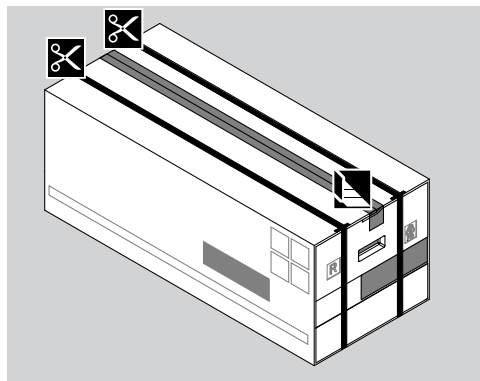

4.2.2 To remove the accessories from the indoor unit

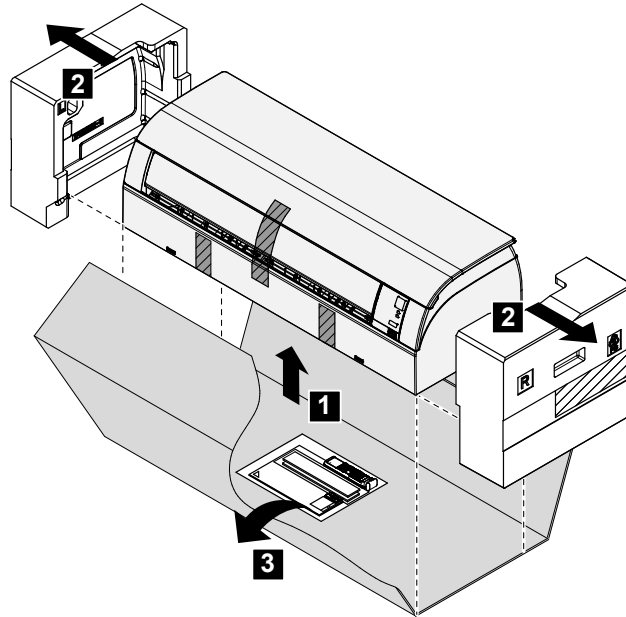

1 Remove the accessories located at the bottom of the package.

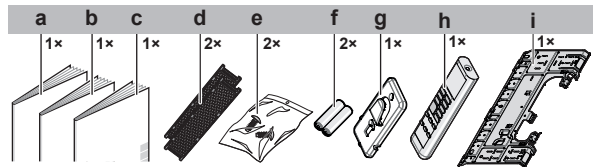

- a Installation manual
- b Operation manual
- c General safety precautions
- d Indoor unit fixing screw (M4x12L). Refer to ["9.3 To fix the unit on the mounting plate"](#) ▶ 43].
- e Dry battery AAA.LR03 (alkaline) for user interface
- f User interface holder
- g User interface
- h Mounting plate

5 About the unit



WARNING: MILDLY FLAMMABLE MATERIAL

The refrigerant inside this unit is mildly flammable.

5.1 System layout



NOTICE

Design of the system must not be done at temperatures below -15°C .

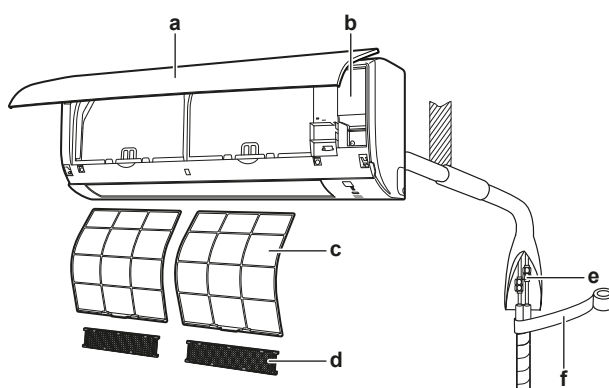

- a Indoor unit
- b Service lid
- c Air filter
- d Refrigerant piping, drain hose and interconnection cable
- e Insulation tape

5.2 Operation range

Use the system in the following temperature and humidity ranges for safe and effective operation.

Operation mode	Operation range
Cooling ^{(a)(b)}	<ul style="list-style-type: none"> ▪ Outdoor temperature: $-10\sim 46^{\circ}\text{C}$ DB ▪ Indoor temperature: $18\sim 32^{\circ}\text{C}$ DB ▪ Indoor humidity: $\leq 80\%$
Heating ^(a)	<ul style="list-style-type: none"> ▪ Outdoor temperature: $-15\sim 24^{\circ}\text{C}$ DB ▪ Indoor temperature: $10\sim 30^{\circ}\text{C}$ DB
Drying ^(a)	<ul style="list-style-type: none"> ▪ Outdoor temperature: $-10\sim 46^{\circ}\text{C}$ DB ▪ Indoor temperature: $18\sim 32^{\circ}\text{C}$ DB ▪ Indoor humidity: $\leq 80\%$

^(a) A safety device might stop the operation of the system if the unit runs outside its operation range.

^(b) Condensation and water dripping might occur if the unit runs outside its operation range.

6 Unit installation

In this chapter

6.1	Preparing the installation site	24
6.1.1	Installation site requirements of the indoor unit	24
6.2	Opening the indoor unit	25
6.2.1	To remove the front panel	25
6.2.2	To re-install the front panel	26
6.2.3	To remove the front grille	26
6.2.4	To re-install the front grille	27
6.2.5	To remove the electrical wiring box cover	27
6.2.6	To open the service cover	27
6.3	Installing the indoor unit	28
6.3.1	Precautions when installing the indoor unit	28
6.3.2	To install the mounting plate	28
6.3.3	To drill a wall hole	28
6.3.4	To remove the pipe port cover	29
6.3.5	To provide drainage	29

6.1 Preparing the installation site

Choose an installation location with sufficient space for carrying the unit in and out of the site.

Do NOT install the unit in places often used as work place. In case of construction works (e.g. grinding works) where a lot of dust is created, the unit MUST be covered.



WARNING

The appliance shall be stored in a room without continuously operating ignition sources (example: open flames, an operating gas appliance or an operating electric heater).



WARNING

Make sure installation, servicing, maintenance and repair comply with instructions from Daikin and with applicable legislation and are executed ONLY by authorised persons.

6.1.1 Installation site requirements of the indoor unit



INFORMATION

Also read the precautions and requirements in the "[2 General safety precautions](#)" [▶ 6].



INFORMATION

The sound pressure level is less than 70 dBA.

- **Air flow.** Make sure nothing blocks the air flow.
- **Drainage.** Make sure condensation water can be evacuated properly.
- **Wall insulation.** When conditions in the wall exceed 30°C and a relative humidity of 80%, or when fresh air is inducted into the wall, then additional insulation is required (minimum 10 mm thickness, polyethylene foam).

- **Wall strength.** Check whether the wall or the floor is strong enough to support the weight of the unit. If there is a risk, reinforce the wall or the floor before installing the unit.

Install power cables at least 1 metre away from televisions or radios to prevent interference. Depending on the radio waves, a distance of 3 metres may NOT be sufficient.

- Choose a location where the operation noise or the hot/cold air discharged from the unit will not disturb anyone.
- **Fluorescent lights.** When installing a wireless user interface in a room with fluorescent lights, mind the following to avoid interference:
 - Install the wireless user interface as close as possible to the indoor unit.
 - Install the indoor unit as far as possible from the fluorescent lights.

It is NOT recommended to install the unit in the following places because it may shorten the life of the unit:

- Where the voltage fluctuates a lot
- In vehicles or vessels
- Where acidic or alkaline vapour is present
- In places where a mineral oil mist, spray or vapour may be present in the atmosphere. Plastic parts may deteriorate and fall off or cause water leakage.
- In places where the unit would be in the path of direct sunlight.
- In bathrooms.
- Sound sensitive areas (e.g. near a bedroom), so that the operation noise will cause no trouble.



WARNING

Do NOT place objects below the indoor and/or outdoor unit that may get wet. Otherwise condensation on the unit or refrigerant pipes, air filter dirt or drain blockage may cause dripping, and objects under the unit may get dirty or damaged.

- **Spacing.** Install the unit at least 1.8 m from the floor and keep the following requirements in mind for distances from the walls and the ceiling:

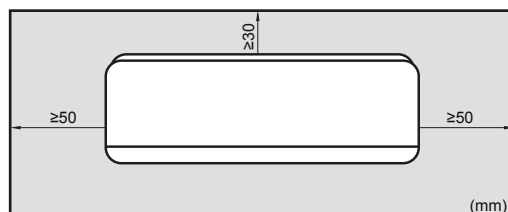

6.2 Opening the indoor unit

6.2.1 To remove the front panel

- 1 Hold the front panel by the panel tabs on both sides and open it.

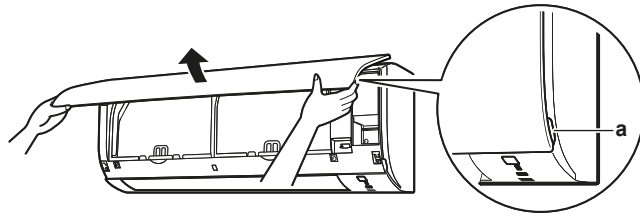

a Panel tabs

- 2 Remove the front panel by sliding it to the left or the right and pulling it toward you.

Result: The front panel shaft on 1 side will be disconnected.

- 3 Disconnect the front panel shaft on the other side in the same manner.

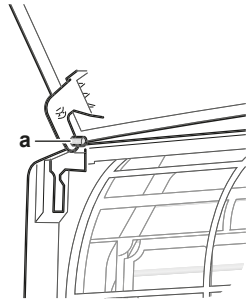

a Front panel shaft

6.2.2 To re-install the front panel

- 1 Attach the front panel. Align the shafts with the slots and push them all the way in.
- 2 Close the front panel slowly; press at both sides and at the centre.

6.2.3 To remove the front grille



CAUTION

Wear adequate personal protective equipment (protective gloves, safety glasses,...) when installing, maintaining or servicing the system.

- 1 Remove the front panel to remove the air filter.
- 2 Remove 2 screws from the front grille.
- 3 Push down the 3 upper hooks marked with a symbol with 3 circles.

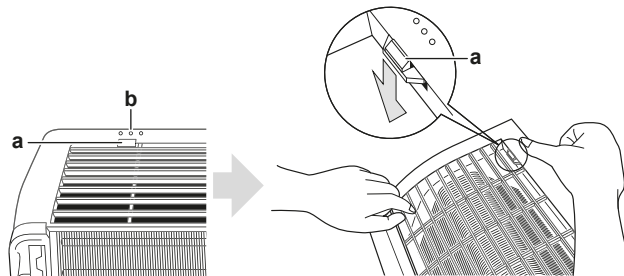

a Upper hook
b Symbol with 3 circles

- 4 We recommend opening the flap before removing the front grille.
- 5 Place both hands under the centre of the front grille, push it up and then toward you.

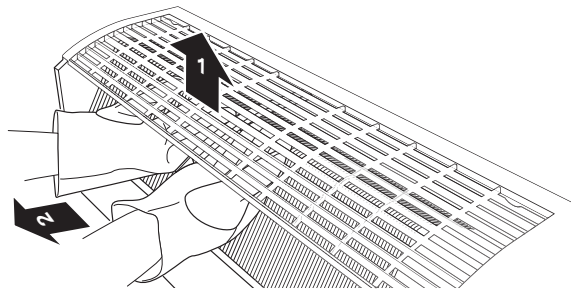

6.2.4 To re-install the front grille

- 1 Install the front grille and firmly engage the 3 upper hooks.
- 2 Install 2 screws back on the front grille.
- 3 Install the air filter and then mount the front panel.

6.2.5 To remove the electrical wiring box cover

- 1 Remove the front grille.
- 2 Remove 1 screw from the electrical wiring box.
- 3 Open the electrical wiring box cover by pulling the protruding part on the top of the cover.
- 4 Unhook the tab on the bottom and remove the electrical wiring box cover.

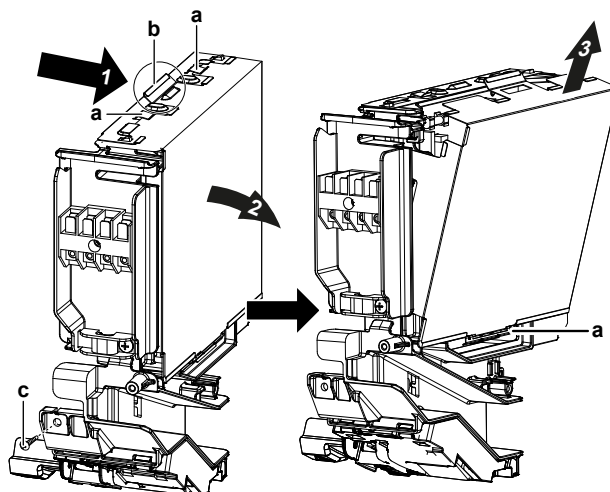

- a Tab
- b Protruding part on the top of the cover
- c Screw

6.2.6 To open the service cover

- 1 Remove 1 screw from the service cover.
- 2 Pull out the service cover horizontally away from the unit.

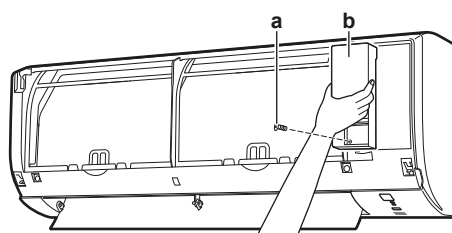

- a Service cover screw

b Service cover

6.3 Installing the indoor unit

6.3.1 Precautions when installing the indoor unit



INFORMATION

Also read the precautions and requirements in the following chapters:

- General safety precautions
- Preparation

6.3.2 To install the mounting plate

- 1 Install the mounting plate temporarily.
- 2 Level the mounting plate.
- 3 Mark the centres of the drilling points on the wall using a tape measure. Position the end of tape measure at symbol "▷".
- 4 Finish the installation by securing the mounting plate on the wall using M4×25L screws (field supply).



INFORMATION

The removed pipe port cover can be kept in the mounting plate pocket.

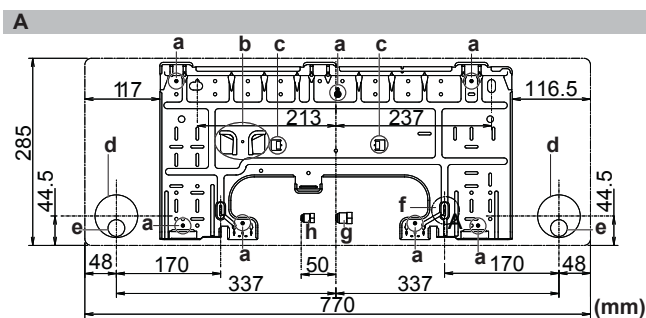

- A Mounting plate for class 20~42
- a Recommended mounting plate fixing spots
- b Pocket for the pipe port cover
- c Tabs for placing a spirit level
- d Through-the-wall hole $\varnothing 65$ mm
- e Drain hose position
- f Position for the tape measure at symbol "▷"
- g Gas pipe end
- h Liquid pipe end

6.3.3 To drill a wall hole



CAUTION

For walls containing a metal frame or a metal board, use a wall embedded pipe and wall cover in the feed-through hole to prevent possible heat, electrical shock, or fire.



NOTICE

Be sure to seal the gaps around the pipes with sealing material (field supply), in order to prevent water leakage.

- 1 Bore a 65 mm large feed-through hole in the wall with a downward slope towards the outside.
- 2 Insert a wall embedded pipe into the hole.
- 3 Insert a wall cover into the wall pipe.

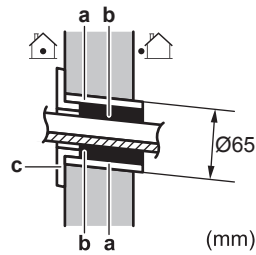

- a** Wall embedded pipe
b Putty
c Wall hole cover

- 4 After completing wiring, refrigerant piping and drain piping, do NOT forget to seal the gap with putty.

6.3.4 To remove the pipe port cover



INFORMATION

To connect the piping on right-side, right-bottom, left-side or left-bottom, the pipe port cover MUST be removed.

- 1 Cut off the pipe port cover from inside the front grille using a coping saw.

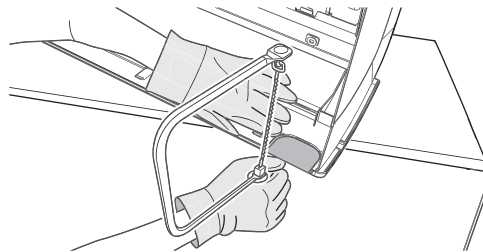

- 2 Remove any burrs along the cut section using a half round needle file.

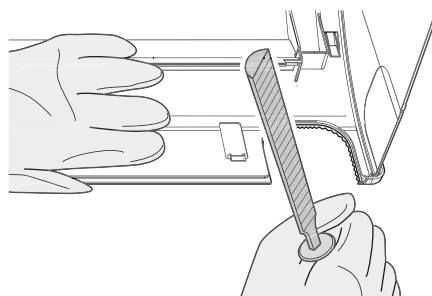

NOTICE

Do NOT use nippers to remove the pipe port cover, as this would damage the front grille.

6.3.5 To provide drainage

Make sure condensation water can be evacuated properly. This involves:

- General guidelines
- Connecting the drain piping to the indoor unit

- Checking for water leaks

General guidelines

- **Pipe length.** Keep drain piping as short as possible.
- **Pipe size.** If drain hose extension or embedded drain piping is required, use appropriate parts that match the hose front end.

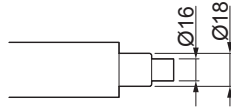

NOTICE

- Install the drain hose with a downward slope.
- Traps are NOT permitted.
- Do NOT put the end of the hose in water.

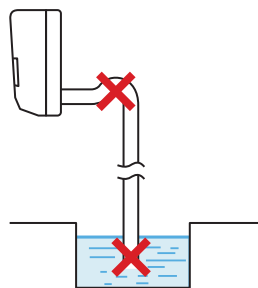

- **Drain hose extension.** To extend the drain hose, use a field supplied hose with inner Ø16 mm. Do NOT forget to use a heat insulation tube on the indoor section of the extension hose.

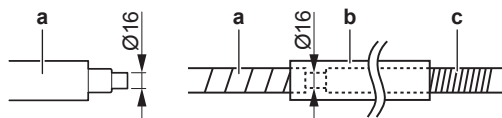

- a Drain hose supplied with the indoor unit
- b Heat insulation tube (field supply)
- c Extension drain hose

- **Rigid polyvinyl chloride pipe.** When connecting a rigid polyvinyl chloride pipe (nominal Ø13 mm) directly to the drain hose as with embedded piping work, use a field supplied drain socket (nominal Ø13 mm).

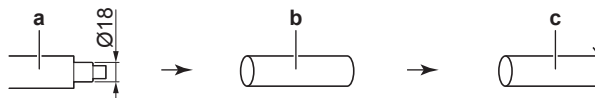

- a Drain hose supplied with the indoor unit
- b Drain socket with nominal Ø13 mm (field supply)
- c Rigid polyvinyl chloride pipe (field supply)

- **Condensation.** Take measures against condensation. Insulate the complete drain piping in the building.

- 1 Insert the drain hose in the drain pipe as shown in the following figure, so it will NOT be pulled out of the drain pipe.

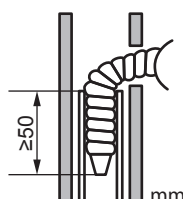

To connect the piping on right side, right-back, or right-bottom



INFORMATION

The factory default is right-side piping. For left-side piping, remove the piping from the right side and install it on the left side.

- 1 Attach the drain hose with adhesive vinyl tape to the bottom of the refrigerant pipes.
- 2 Wrap the drain hose and the refrigerant pipes together using insulation tape.

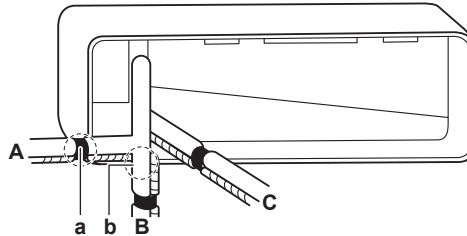

- A Right-side piping
- B Right-bottom piping
- C Right-back piping
- a Remove the pipe port cover here for right side piping
- b Remove the pipe port cover here for right-bottom piping

To connect the piping on left side, left-back, or left-bottom



INFORMATION

The factory default is right-side piping. For left-side piping, remove the piping from the right side and install it on the left side.

- 1 Remove the insulation fixing screw on the right side and remove the drain hose.
- 2 Remove the drain plug on the left side and attach it to the right side.



NOTICE

Do NOT apply lubricating oil (refrigerant oil) to the drain plug when inserting it. The drain plug may deteriorate and cause drain leakage from the plug.

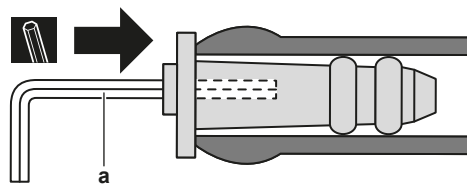

- a 4 mm hexagonal wrench

- 3 Insert the drain hose on the left side and do not forget to tighten it with the fixing screw; otherwise water leakage may occur.

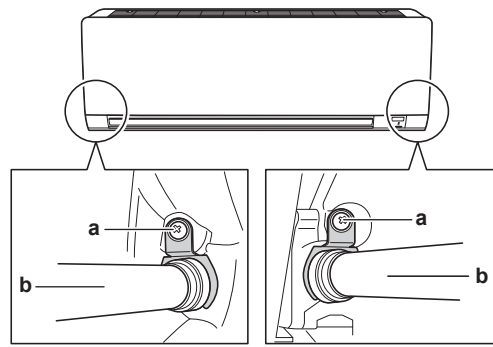

- a Insulation fixing screw
- b Drain hose

- 4 Attach the drain hose to the refrigerant piping bottom side using adhesive vinyl tape.

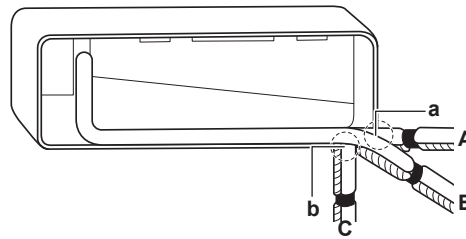

- A Left-side piping
- B Left-back piping
- C Left-bottom piping
- a Remove the pipe port cover here for left-side piping
- b Remove the pipe port cover here for left-bottom piping

To check for water leaks

- 1 Remove the air filters.
- 2 Gradually pour approximately 1 l of water in the drain pan, and check for water leaks.

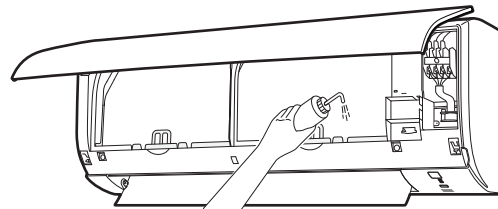

7 Piping installation

In this chapter

7.1	Preparing refrigerant piping	33
7.1.1	Refrigerant piping requirements	33
7.1.2	Refrigerant piping insulation	34
7.2	Connecting the refrigerant piping	34
7.2.1	About connecting the refrigerant piping	34
7.2.2	Precautions when connecting the refrigerant piping	34
7.2.3	Guidelines when connecting the refrigerant piping	35
7.2.4	Pipe bending guidelines	36
7.2.5	To flare the pipe end	36
7.2.6	To connect the refrigerant piping to the indoor unit	37

7.1 Preparing refrigerant piping

7.1.1 Refrigerant piping requirements



INFORMATION

Also read the precautions and requirements in the "2 General safety precautions" [▶ 6].



NOTICE

The piping and other pressure-containing parts shall be suitable for refrigerant. Use phosphoric acid deoxidised seamless copper for refrigerant.

- Foreign materials inside pipes (including oils for fabrication) must be ≤ 30 mg/10 m.



Refrigerant piping diameter

Use the same diameters as the connections on the outdoor units:

Class	L1 liquid piping	L1 gas piping
20~42	Ø6.4	Ø9.5

Refrigerant piping material

- Piping material:** Phosphoric acid deoxidised seamless copper.
- Flare connections:** Only use annealed material.
- Piping temper grade and thickness:**

Outer diameter (Ø)	Temper grade	Thickness (t) ^(a)	
6.4 mm (1/4")	Annealed (O)	≥0.8 mm	
9.5 mm (3/8")			
12.7 mm (1/2")			

^(a) Depending on the applicable legislation and the maximum working pressure of the unit (see "PS High" on the unit name plate), larger piping thickness might be required.

7.1.2 Refrigerant piping insulation

- Use polyethylene foam as insulation material:
 - with a heat transfer rate between 0.041 and 0.052 W/mK (0.035 and 0.045 kcal/mh°C)
 - with a heat resistance of at least 120°C
- Insulation thickness

Pipe outer diameter (ϕ_p)	Insulation inner diameter (ϕ_i)	Insulation thickness (t)
6.4 mm (1/4")	8~10 mm	≥10 mm
9.5 mm (3/8")	12~15 mm	≥13 mm
12.7 mm (1/2")	14~16 mm	≥13 mm

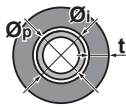

If the temperature is higher than 30°C and the humidity is higher than RH 80%, the thickness of the insulation materials should be at least 20 mm to prevent condensation on the surface of the insulation.

7.2 Connecting the refrigerant piping

7.2.1 About connecting the refrigerant piping

Before connecting the refrigerant piping

Make sure the outdoor and indoor unit are mounted.

Typical workflow

Connecting the refrigerant piping involves:

- Connecting the refrigerant piping to the indoor unit
- Connecting the refrigerant piping to the outdoor unit
- Insulating the refrigerant piping
- Keeping in mind the guidelines for:
 - Pipe bending
 - Flaring pipe ends
 - Using the stop valves

7.2.2 Precautions when connecting the refrigerant piping



INFORMATION

Also read the precautions and requirements in the following chapters:

- General safety precautions
- Preparation



DANGER: RISK OF BURNING/SCALDING

 **CAUTION**

- Use the flare nut fixed to the unit.
- To prevent gas leakage, apply refrigeration oil **ONLY** to the inside of the flare. Use refrigeration oil for R32.
- Do **NOT** reuse joints.

 **CAUTION**

- Do **NOT** use mineral oil on flared part.
- NEVER** install a drier to this R32 unit to guarantee its lifetime. The drying material may dissolve and damage the system.

 **NOTICE**

Take the following precautions on refrigerant piping into account:

- Avoid anything but the designated refrigerant to get mixed into the refrigerant cycle (e.g. air).
- Only use R32 when adding refrigerant.
- Only use installation tools (e.g. manifold gauge set) that are exclusively used for R32 installations to withstand the pressure and to prevent foreign materials (e.g. mineral oils and moisture) from mixing into the system.
- Install the piping so that the flare is **NOT** subjected to mechanical stress.
- Protect the piping as described in the following table to prevent dirt, liquid or dust from entering the piping.
- Use caution when passing copper tubes through walls (see figure below).

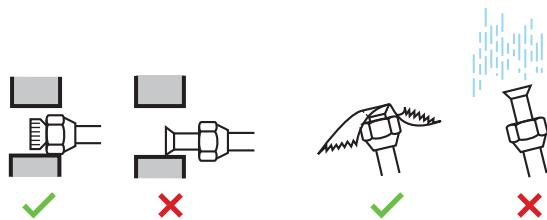

Unit	Installation period	Protection method
Outdoor unit	>1 month	Pinch the pipe
	<1 month	Pinch or tape the pipe
Indoor unit	Regardless of the period	

 **INFORMATION**

Do **NOT** open the refrigerant stop valve before checking the refrigerant piping. When you need to charge additional refrigerant it is recommended to open the refrigerant stop valve after charging.

7.2.3 Guidelines when connecting the refrigerant piping

Take the following guidelines into account when connecting pipes:

- Coat the flare inner surface with ether oil or ester oil when connecting a flare nut. Tighten 3 or 4 turns by hand, before tightening firmly.

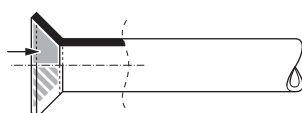

- ALWAYS use 2 wrenches together when loosening a flare nut.
- ALWAYS use a spanner and torque wrench together to tighten the flare nut when connecting the piping. This to prevent nut cracking and leaks.

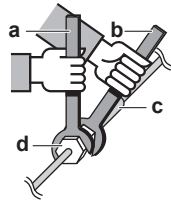

- a Torque wrench
- b Spanner
- c Piping union
- d Flare nut

Piping size (mm)	Tightening torque (N•m)	Flare dimensions (A) (mm)	Flare shape (mm)
∅6.4	15~17	8.7~9.1	
∅9.5	33~39	12.8~13.2	
∅12.7	50~60	16.2~16.6	

7.2.4 Pipe bending guidelines

Use a pipe bender for bending. All pipe bends should be as gentle as possible (bending radius should be 30~40 mm or larger).

7.2.5 To flare the pipe end

CAUTION

- Incomplete flaring may cause refrigerant gas leakage.
- Do NOT re-use flares. Use new flares to prevent refrigerant gas leakage.
- Use flare nuts that are included with the unit. Using different flare nuts may cause refrigerant gas leakage.

- 1 Cut the pipe end with a pipe cutter.
- 2 Remove burrs with the cut surface facing down so that the chips do NOT enter the pipe.

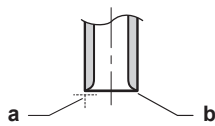

- a Cut exactly at right angles.
- b Remove burrs.

- 3 Remove the flare nut from the stop valve and put the flare nut on the pipe.
- 4 Flare the pipe. Set exactly at the position as shown in the following figure.

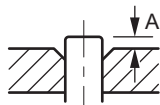

	Flare tool for R32 (clutch type)	Conventional flare tool	
		Clutch type (Ridgid-type)	Wing nut type (Imperial-type)
A	0~0.5 mm	1.0~1.5 mm	1.5~2.0 mm

5 Check that the flaring is properly made.

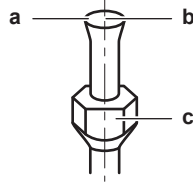

- a Flare's inner surface MUST be flawless.
- b The pipe end MUST be evenly flared in a perfect circle.
- c Make sure the flare nut is fitted.

7.2.6 To connect the refrigerant piping to the indoor unit



WARNING: MILDLY FLAMMABLE MATERIAL

The refrigerant inside this unit is mildly flammable.

▪ **Pipe length.** Keep refrigerant piping as short as possible.

- 1 Connect refrigerant piping to the unit using **flare connections**.
- 2 **Insulate** the refrigerant piping, interconnection cable and drain hose on the indoor unit as follows:

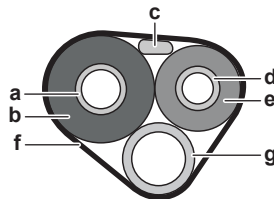

- a Gas pipe
- b Gas pipe insulation
- c Interconnection cable
- d Liquid pipe
- e Liquid pipe insulation
- f Finishing tape
- g Drain hose



NOTICE

Make sure to insulate all refrigerant piping. Any exposed piping might cause condensation.

8 Electrical installation

In this chapter

8.1	Connecting the electrical wiring.....	38
8.1.1	About connecting the electrical wiring.....	38
8.1.2	Precautions when connecting the electrical wiring	38
8.1.3	Guidelines when connecting the electrical wiring	39
8.1.4	Specifications of standard wiring components	40
8.1.5	To connect the electrical wiring to the indoor unit.....	40

8.1 Connecting the electrical wiring

8.1.1 About connecting the electrical wiring

Typical workflow

Connecting the electrical wiring typically consists of the following stages:

- 1 Making sure the power supply system complies with the electrical specifications of the units.
- 2 Connecting the electrical wiring to the outdoor unit.
- 3 Connecting the electrical wiring to the indoor unit.
- 4 Connecting the main power supply.

8.1.2 Precautions when connecting the electrical wiring



INFORMATION

Also read the precautions and requirements in the following chapters:

- General safety precautions
- Preparation



DANGER: RISK OF ELECTROCUTION



WARNING

ALWAYS use multicore cable for power supply cables.



WARNING

Use an all-pole disconnection type breaker with at least 3 mm between the contact point gaps that provide full disconnection under overvoltage category III.



WARNING

If the supply cord is damaged, it MUST be replaced by the manufacturer, its service agent or similarly qualified persons in order to avoid a hazard.



WARNING

Do NOT connect the power supply to the indoor unit. This could result in electrical shock or fire.



WARNING

- Do NOT use locally purchased electrical parts inside the product.
- Do NOT branch the power supply for the drain pump, etc. from the terminal block. This could result in electrical shock or fire.



WARNING

Keep the interconnection wiring away from copper pipes without thermal insulation as such pipes will be very hot.

8.1.3 Guidelines when connecting the electrical wiring

Keep the following in mind:

- If stranded conductor wires are used, install a round crimp-style terminal on the end of the wire. Place the round crimp-style terminal on the wire up to the covered part and fasten the terminal with the appropriate tool.

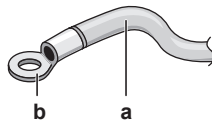

- a Stranded conductor wire
- b Round crimp-style terminal

- Use the following methods for installing wires:

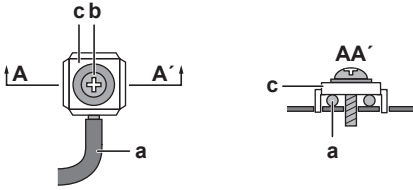
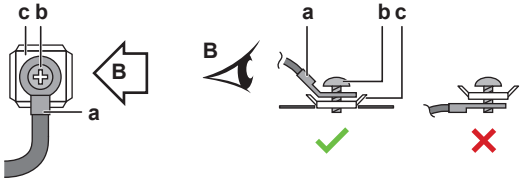
Wire type	Installation method
Single-core wire	 <p>a Curled single-core wire b Screw c Flat washer</p>
Stranded conductor wire with round crimp-style terminal	 <p>a Terminal b Screw c Flat washer ✓ Allowed ✗ NOT allowed</p>

Tightening torques

Item	Tightening torque (N•m)
M4 (X1M)	1.2
M4 (earth)	

- The earth wire between the wire retainer and the terminal must be longer than the other wires.

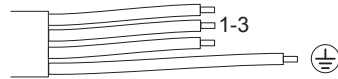

8.1.4 Specifications of standard wiring components

Component	
Interconnection cable (indoor↔outdoor)	4-core cable 1.5 mm ² ~2.5 mm ² and applicable for 220~240 V H05RN-F (60245 IEC 57)

8.1.5 To connect the electrical wiring to the indoor unit

Electrical work should be carried out in accordance with the installation manual and the national electrical wiring rules or code of practice.

- 1 Set the indoor unit on the mounting plate hooks. Use the "Δ" marks as a guide.

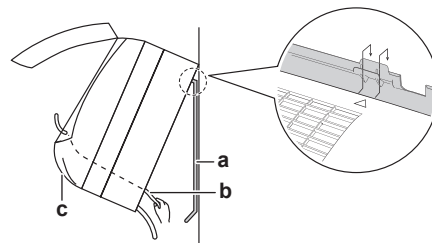

- a Mounting plate (accessory)
- b Interconnection cable
- c Wire guide

- 2 Open the front panel, and then the service cover. Refer to "6.2 Opening the indoor unit" [▶ 25].
- 3 Pass the interconnection cable from the outdoor unit through the feed-through wall hole, through the back of the indoor unit and through the front side.

Note: In case the interconnection cable was stripped in advance, cover the ends with insulating tape.

- 4 Bend the end of the cable up.



NOTICE

- Be sure to keep the power line and transmission line apart from each other. Transmission wiring and power supply wiring may cross, but may NOT run parallel.
- In order to avoid any electrical interference the distance between both wirings should ALWAYS be at least 50 mm.



WARNING

Provide adequate measures to prevent that the unit can be used as a shelter by small animals. Small animals that make contact with electrical parts can cause malfunctions, smoke or fire.

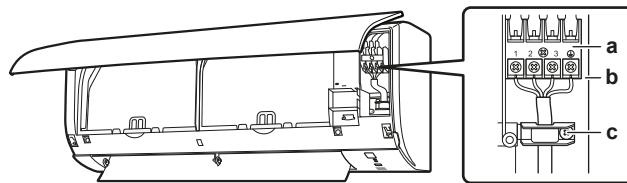

- a Terminal block
- b Electrical component block
- c Cable clamp

- 5 Strip the wire ends approximately 15 mm.
- 6 Match wire colours with terminal numbers on the indoor unit terminal blocks and firmly screw the wires to the corresponding terminals.
- 7 Connect the earth wire to the corresponding terminal.
- 8 Firmly fix the wires with the terminal screws.
- 9 Pull the wires to make sure that they are securely attached, then retain the wires with the wire retainer.
- 10 Shape the wires so that the service cover fits securely, then close the service cover.

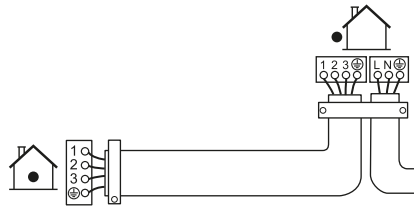

9 Finishing the indoor unit installation

9.1 To insulate the drain piping, refrigerant piping and interconnection cable

- 1 After the drain piping, refrigerant piping and the electrical wiring are finished. Wrap refrigerant pipes, interconnection cable and drain hose together using insulation tape. Overlap at least half the width of the tape with each turn.

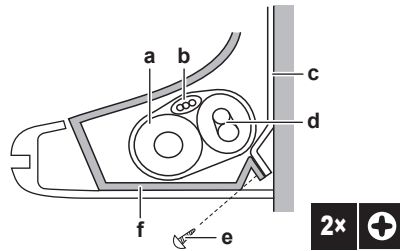

- a Drain hose
- b Interconnection cable
- c Mounting plate (accessory)
- d Refrigerant piping
- e Indoor unit fixing screw M4×12L (accessory)
- f Bottom frame

9.2 To pass the pipes through the wall hole

- 1 Shape the refrigerant pipes along the pipe path marking on the mounting plate.

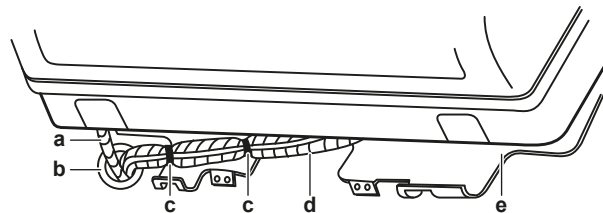

- a Drain hose
- b Caulk this hole with putty or caulking material
- c Adhesive vinyl tape
- d Insulation tape
- e Mounting plate (accessory)



NOTICE

- Do NOT bend refrigerant pipes.
- Do NOT push the refrigerant pipes onto the bottom frame or the front grille.

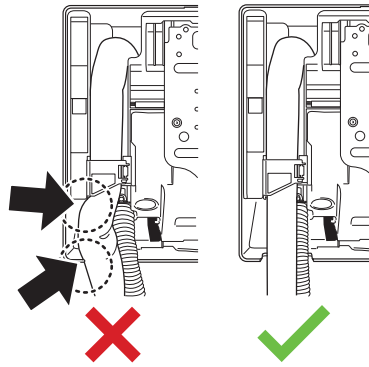

- 2 Pass the drain hose and refrigerant pipes through the wall hole.

9.3 To fix the unit on the mounting plate

- 1 Set the indoor unit on the mounting plate hooks. Use the "Δ" marks as a guide.

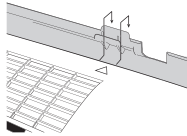

- 2 Press the bottom frame of the unit with both hands to set it on the bottom hooks of the mounting plate. Make sure that the wires do NOT get squeezed anywhere.

Note: Take care that the interconnection cable does NOT get caught in the indoor unit.

- 3 Press the bottom edge of the indoor unit with both hands until it is firmly caught by the mounting plate hooks.
- 4 Secure the indoor unit to the mounting plate using 2 indoor unit fixing screws M4×12L (accessory).

10 Configuration

10.1 To set a different address

In case 2 indoor units are installed in 1 room, different addresses for 2 user interfaces can be set.

- 1 Remove the batteries from the user interface.
- 2 Cut the address jumper.

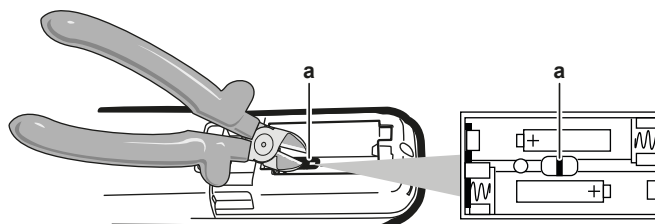

a Address jumper



NOTICE

Be careful NOT to damage any of the surrounding parts when cutting the address jumper.

- 3 Turn the power supply on.



Result: The flap of the indoor unit will open and close to set the reference position.



INFORMATION

- For FTXF and ATXF units, the following setting MUST be completed within 5 minutes after the power supply is turned on.
- In case you could NOT complete the setting in time, turn the power supply off and wait at least 1 minute before turning the power supply back on.

- 4 Press simultaneously:

Model	Buttons
FTXF, ATXF	MODE,  and 

- 5 Press:

Model	Button
FTXF, ATXF	

- 6 Select:

Model	Symbol
FTXF, ATXF	7

- 7 Press:

Model	Button
FTXF, ATXF	

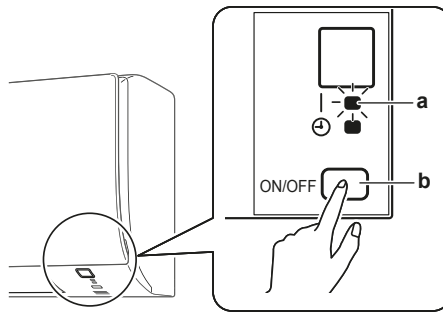

- a Operation lamp
- b Indoor unit ON/OFF switch

8 Press the indoor unit ON/OFF switch while the operation lamp is blinking.

Jumper	Address
Factory setting	1
After cutting with nippers	2



INFORMATION

If the setting could NOT be completed while the operation lamp was blinking, repeat the setting process from the beginning.

9 When the setting is complete, press:

Model	Button
FTXF, ATXF	

Result: The user interface will return to the previous screen.

11 Commissioning

11.1 Overview: Commissioning

This chapter describes what you have to do and know to commission the system after it is installed.

Typical workflow

Commissioning typically consists of the following stages:

- 1 Checking the "Checklist before commissioning".
- 2 Performing a test run for the system.

11.2 Checklist before commissioning

After the installation of the unit, first check the items listed below. Once all checks are fulfilled, the unit **MUST** be closed. Power-up the unit after it is closed.

<input type="checkbox"/>	You read the complete installation instructions, as described in the installer reference guide .
<input type="checkbox"/>	The indoor units are properly mounted.
<input type="checkbox"/>	The outdoor unit is properly mounted.
<input type="checkbox"/>	Air inlet/outlet Check that the air inlet and outlet of the unit is NOT obstructed by paper sheets, cardboard, or any other material.
<input type="checkbox"/>	There are NO missing phases or reversed phases .
<input type="checkbox"/>	The refrigerant pipes (gas and liquid) are thermally insulated.
<input type="checkbox"/>	Drainage Make sure drainage flows smoothly. Possible consequence: Condensate water might drip.
<input type="checkbox"/>	The system is properly earthed and the earth terminals are tightened.
<input type="checkbox"/>	The fuses or locally installed protection devices are installed according to this document, and have NOT been bypassed.
<input type="checkbox"/>	The power supply voltage matches the voltage on the identification label of the unit.
<input type="checkbox"/>	The specified wires are used for the interconnection cable .
<input type="checkbox"/>	The indoor unit receives the signals of the user interface .
<input type="checkbox"/>	There are NO loose connections or damaged electrical components in the switch box.
<input type="checkbox"/>	The insulation resistance of the compressor is OK.
<input type="checkbox"/>	There are NO damaged components or squeezed pipes on the inside of the indoor and outdoor units.
<input type="checkbox"/>	There are NO refrigerant leaks .
<input type="checkbox"/>	The correct pipe size is installed and the pipes are properly insulated.



The **stop valves** (gas and liquid) on the outdoor unit are fully open.

11.3 To perform a test run

Prerequisite: Power supply **MUST** be in the specified range.





Prerequisite: Test run may be performed in cooling or heating mode.

Prerequisite: Test run should be performed in accordance with the operation manual of the indoor unit to make sure that all functions and parts are working properly.

- 1 In cooling mode, select the lowest programmable temperature. In heating mode, select the highest programmable temperature. Test run can be disabled if necessary.
- 2 When the test run is finished, set the temperature to a normal level. In cooling mode: 26~28°C, in heating mode: 20~24°C.
- 3 The system stops operating 3 minutes after the unit is turned OFF.

11.3.1 To perform a test run in winter season





When operating the air conditioner in **Cooling** mode in winter, set it to test run operation using the following method.

- 1 Press , , and simultaneously.
- 2 Press .
- 3 Select 7°.
- 4 Press .
- 5 Press  to switch the system on.

Result: Test run operation will stop automatically after about 30 minutes.

- 6 To stop operation, press .

For FTXF and ATXF units

- 1 Press  to switch the system on.
- 2 Press the centre of , , and  simultaneously.
- 3 Press  twice.

Result: 7° will appear on the display. Test run operation is selected. Test run operation will stop automatically after about 30 minutes.

- 4 To stop operation, press .



INFORMATION

Some of the functions **CANNOT** be used in the test run operation mode.

If a power failure occurs during operation, the system automatically restarts immediately after power is restored.

12 Hand-over to the user

Once the test run is finished and the unit operates properly, please make sure the following is clear for the user:

- Make sure that the user has the printed documentation and ask him/her to keep it for future reference. Inform the user that he can find the complete documentation at the URL mentioned earlier in this manual.
- Explain the user how to properly operate the system and what to do in case of problems.
- Show the user what to do for the maintenance of the unit.

13 Disposal

**NOTICE**

Do NOT try to dismantle the system yourself: dismantling of the system, treatment of the refrigerant, oil and other parts **MUST** comply with applicable legislation. Units **MUST** be treated at a specialised treatment facility for reuse, recycling and recovery.

14 Technical data



















- A **subset** of the latest technical data is available on the regional Daikin website (publicly accessible).
- The **full set** of latest technical data is available on the Daikin Business Portal (authentication required).

14.1 Wiring diagram

The wiring diagram is delivered with the unit, located inside of the outdoor unit (bottom side of the top plate).

14.1.1 Unified wiring diagram legend

For applied parts and numbering, refer to the wiring diagram on the unit. Part numbering is by Arabic numbers in ascending order for each part and is represented in the overview below by "*" in the part code.

Symbol	Meaning	Symbol	Meaning
	Circuit breaker		Protective earth
			
			
	Connection		Protective earth (screw)
	Connector		Rectifier
	Earth		Relay connector
	Field wiring		Short-circuit connector
	Fuse		Terminal
	Indoor unit		Terminal strip
	Outdoor unit		Wire clamp
	Residual current device		

Symbol	Colour	Symbol	Colour
BLK	Black	ORG	Orange
BLU	Blue	PNK	Pink
BRN	Brown	PRP, PPL	Purple
GRN	Green	RED	Red
GRY	Grey	WHT	White
		YLW	Yellow

Symbol	Meaning
A*P	Printed circuit board
BS*	Pushbutton ON/OFF, operation switch

Symbol	Meaning
BZ, H*O	Buzzer
C*	Capacitor
AC*, CN*, E*, HA*, HE*, HL*, HN*, HR*, MR*_A, MR*_B, S*, U, V, W, X*A, K*R_*, NE	Connection, connector
D*, V*D	Diode
DB*	Diode bridge
DS*	DIP switch
E*H	Heater
FU*, F*U, (for characteristics, refer to PCB inside your unit)	Fuse
FG*	Connector (frame ground)
H*	Harness
H*P, LED*, V*L	Pilot lamp, light emitting diode
HAP	Light emitting diode (service monitor green)
HIGH VOLTAGE	High voltage
IES	Intelligent eye sensor
IPM*	Intelligent power module
K*R, KCR, KFR, KHuR, K*M	Magnetic relay
L	Live
L*	Coil
L*R	Reactor
M*	Stepper motor
M*C	Compressor motor
M*F	Fan motor
M*P	Drain pump motor
M*S	Swing motor
MR*, MRCW*, MRM*, MRN*	Magnetic relay
N	Neutral
n=*, N=*	Number of passes through ferrite core
PAM	Pulse-amplitude modulation
PCB*	Printed circuit board
PM*	Power module
PS	Switching power supply
PTC*	PTC thermistor
Q*	Insulated gate bipolar transistor (IGBT)
Q*C	Circuit breaker

Symbol	Meaning
Q*DI, KLM	Earth leak circuit breaker
Q*L	Overload protector
Q*M	Thermo switch
Q*R	Residual current device
R*	Resistor
R*T	Thermistor
RC	Receiver
S*C	Limit switch
S*L	Float switch
S*NG	Refrigerant leak detector
S*NPH	Pressure sensor (high)
S*NPL	Pressure sensor (low)
S*PH, HPS*	Pressure switch (high)
S*PL	Pressure switch (low)
S*T	Thermostat
S*RH	Humidity sensor
S*W, SW*	Operation switch
SA*, F1S	Surge arrester
SR*, WLU	Signal receiver
SS*	Selector switch
SHEET METAL	Terminal strip fixed plate
T*R	Transformer
TC, TRC	Transmitter
V*, R*V	Varistor
V*R	Diode bridge, Insulated-gate bipolar transistor (IGBT) power module
WRC	Wireless remote controller
X*	Terminal
X*M	Terminal strip (block)
Y*E	Electronic expansion valve coil
Y*R, Y*S	Reversing solenoid valve coil
Z*C	Ferrite core
ZF, Z*F	Noise filter

15 Glossary

Dealer

Sales distributor for the product.

Authorised installer

Technical skilled person who is qualified to install the product.

User

Person who is owner of the product and/or operates the product.

Applicable legislation

All international, European, national and local directives, laws, regulations and/or codes that are relevant and applicable for a certain product or domain.

Service company

Qualified company which can perform or coordinate the required service to the product.

Installation manual

Instruction manual specified for a certain product or application, explaining how to install, configure and maintain it.

Operation manual

Instruction manual specified for a certain product or application, explaining how to operate it.

Maintenance instructions

Instruction manual specified for a certain product or application, which explains (if relevant) how to install, configure, operate and/or maintain the product or application.

Accessories

Labels, manuals, information sheets and equipment that are delivered with the product and that need to be installed according to the instructions in the accompanying documentation.

Optional equipment

Equipment made or approved by Daikin that can be combined with the product according to the instructions in the accompanying documentation.

Field supply

Equipment NOT made by Daikin that can be combined with the product according to the instructions in the accompanying documentation.





ERC

DAIKIN ISITMA VE SOĞUTMA SİSTEMLERİ SAN.TİC. A.Ş.

Gülsuyu Mahallesi, Fevzi Çakmak Caddesi, Burçak Sokak, No:20, 34848 Maltepe

İSTANBUL / TÜRKİYE

Tel: 0216 453 27 00

Faks: 0216 671 06 00

Çağrı Merkezi: 444 999 0

Web: www.daikin.com.tr

DAIKIN EUROPE N.V.

Zandvoordestraat 300, B-8400 Oostende, Belgium

4P519439-9J 2021.06

Copyright 2021 Daikin